

Bowers & Wilkins

Custom Installation

CWM Cinema 7

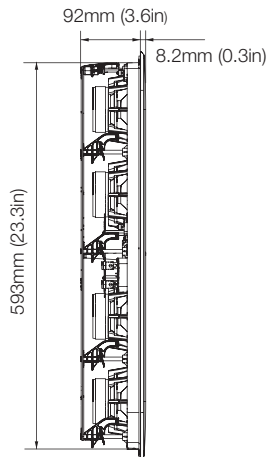
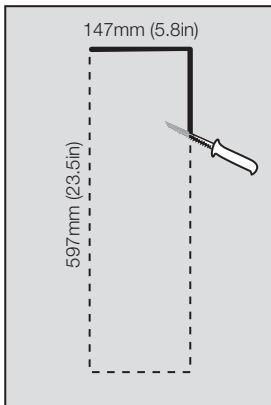
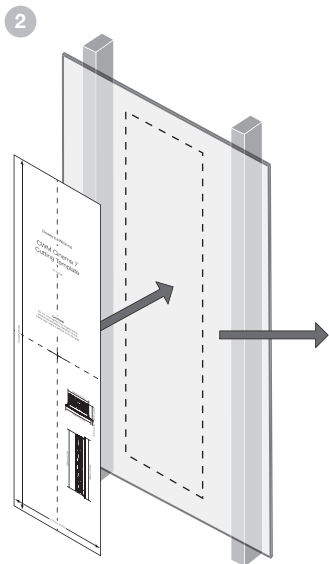
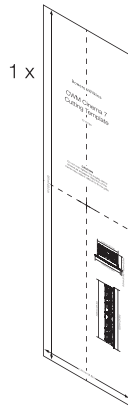
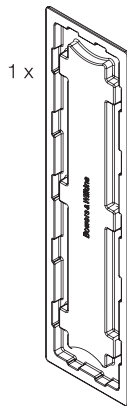
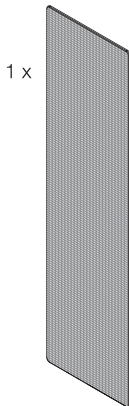
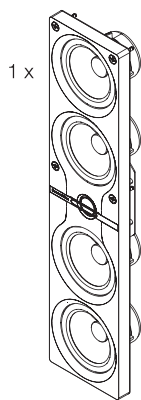
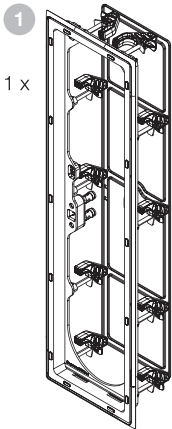

3

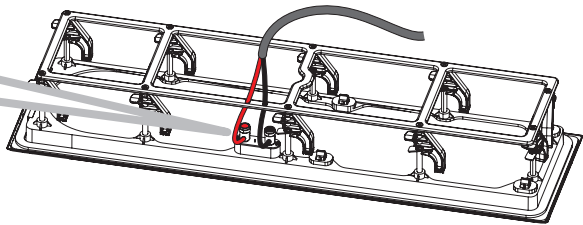
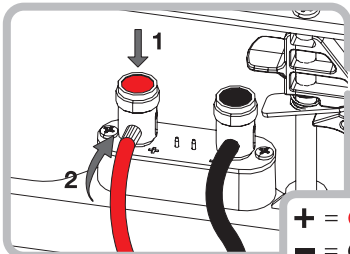

4

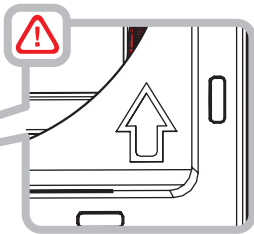
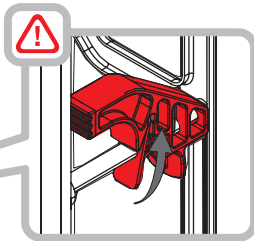
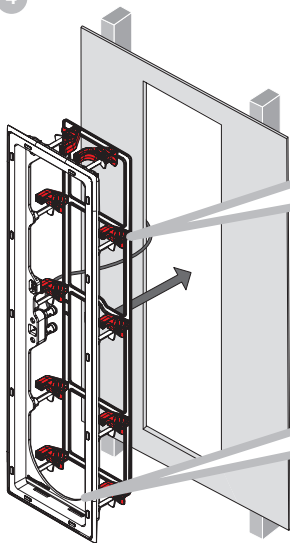

5

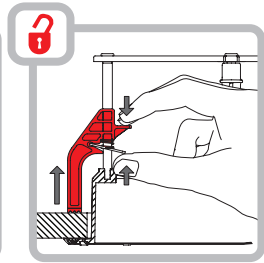
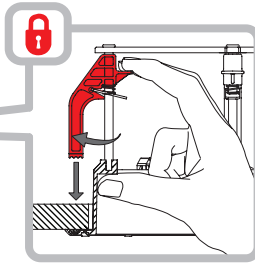
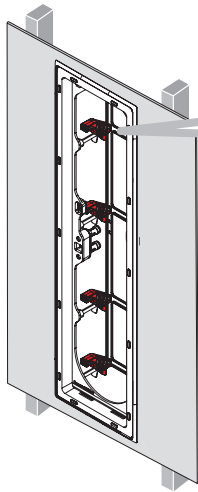

6

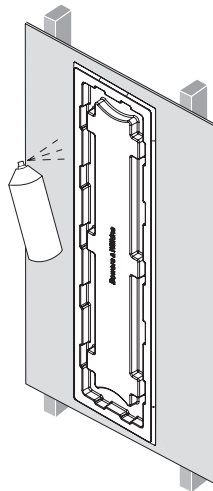
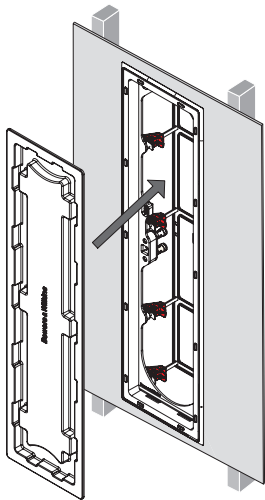

7

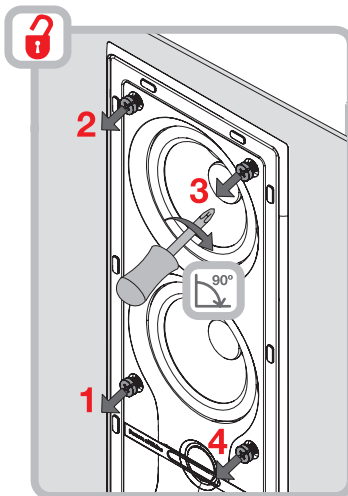
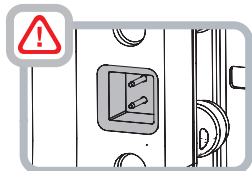
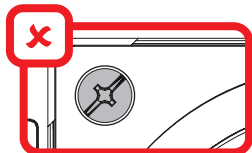
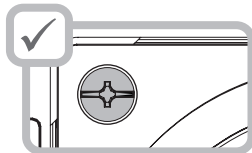
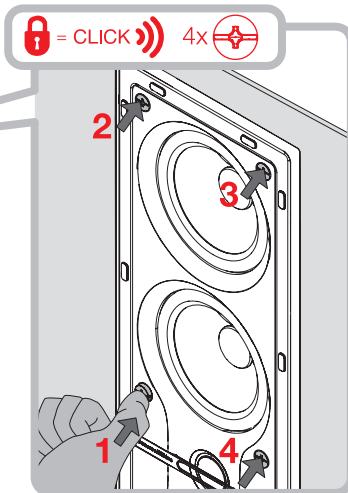
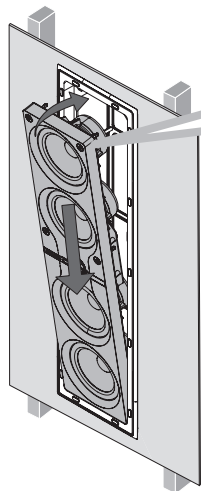

8

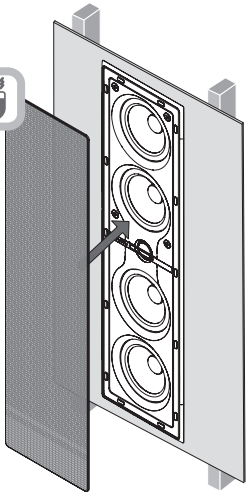

www.bowers-wilkins.com

EU DECLARATION OF CONFORMITY

We,

B&W Group Ltd.

whose registered office is situated at

Dale Road, Worthing, West Sussex, BN11 2BH, United Kingdom

declare under our sole responsibility that the product:

CWM Cinema 7

complies with the EU Electro-Magnetic Compatibility (EMC) Directive 89/336/EEC, in pursuance of which the following standards have been applied:

EN 61000-6-1 : 2007

EN 61000-6-3 : 2007

EN 55020 : 2007

EN 55013 : 2001

and complies with the EU General Product Safety 2001/95/EC, in pursuance of which the following standard has been applied:

BS EN 60065:2002 + A12:2011

This declaration attests that the manufacturing process quality control and product documentation accord with the need to assure continued compliance.

The attention of the user is drawn to any special measures regarding the use of this equipment that may be detailed in the owner's manual.

Signed:

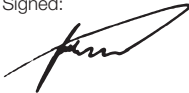
A handwritten signature in black ink, appearing to read 'G Edwards', written over a white background.

G Edwards
Executive Vice President, Operations
B&W Group Ltd.

Bowers & Wilkins

B&W Group Ltd
Dale Road
Worthing West Sussex
BN11 2BH England

T +44 (0) 1903 221 800
F +44 (0) 1903 221 801
info@bwgroup.com
www.bowers-wilkins.com

B&W Group (UK Sales)
T +44 (0) 1903 221 500
E uksales@bwgroup.com

B&W Group North America
T +1 978 664 2870
E marketing@bwgroupusa.com

B&W Group Asia Ltd
T +852 3 472 9300
E info@bwgroup.hk

Copyright © B&W Group Ltd. E&OE
Printed in China.